

# UDS2-77 AREMA

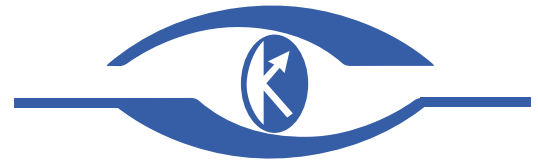

OKOndt GROUP



## Ultrasonic Single Rail Flaw Detector

Complies with: AREMA

# Main Features of the flaw detector

- Weighs just 17 kg (for UDS2-77 AREMA (SL)) and 23 kg (for UDS2-77 AREMA (RSU)) due to light and shock-resistant plastic.
- Flaw detector parking mode.
- Module structure: a frame on rollers, a central electronic unit, multiplexer units, a storage battery, a tank, a couplant supply system, probe units, an encoder.
- All modules are easy to assemble and disassemble; they are safely fixed on the flaw detector frame.
- Adjustable probe unit position in the transverse plane of the rail.
- Centering probe units along the rail axis with adaptive rollers.
- The probe unit suspension system ensures stable acoustic contact in case of lateral inclination of the trolley at up to  $\pm 15^\circ$  (for UDS2-77 AREMA (SL)).



# UDS2 - 77 AREMA Ultrasonic Single Rail Flaw Detector

## Main technical specifications

The UDS2 - 77, an ultrasonic flaw detector, is intended for continuous testing of rails and railway switches, as well as for confirmatory testing of quick test system results. The flaw detector ensures flaw detection in the entire rail cross section, excluding rail base blades.

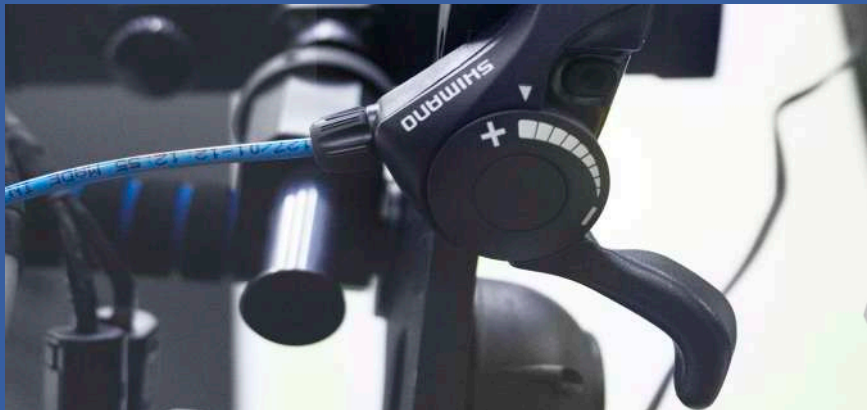

- Rail inspection complies with AREMA requirements.
- Number of inspection channels (probes) - 11 pcs.
- Probe type and frequency:  
0°/4 MHz,  
±70°, ±40/45°, ±50°SL/2 MHz.
- Scanning pitch si 1mm at a speed of 4 km/h.
- Display modes: A-Scan, B-Scan, A-Scan+B-Scan.
- Continuous test result recording in a database format linked to path an GPS coordinates.
- Test result reviewing mode on the screen of the flaw detector.
- Flaw detector weight without couplant: no more than 17 kg (for UDS2-77 AREMA (SL) and 23 kg (for UDS2-77 AREMA (RSU))
- Couplant tank volume: 5 l.
- Couplant consumption: up to 1.5 l/km, at a speed of 4 km/h.

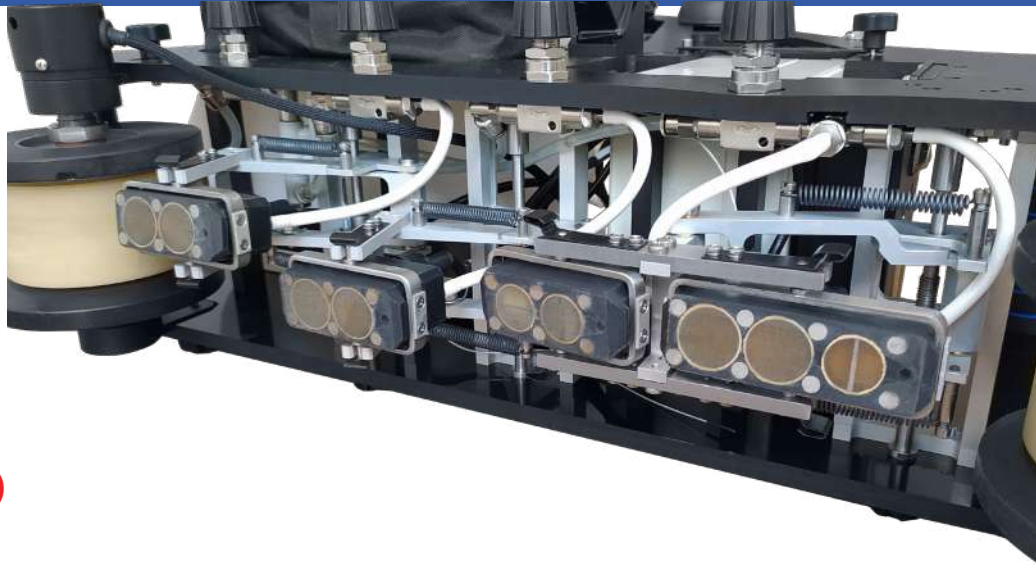
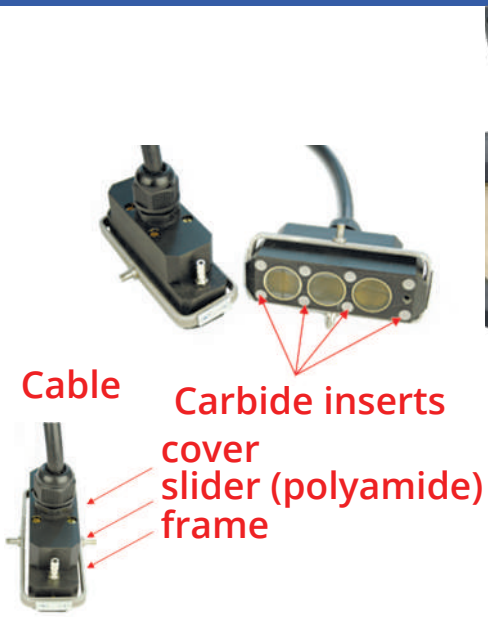

# UDS2-77 AREMA (RSU) WHEEL PROBE

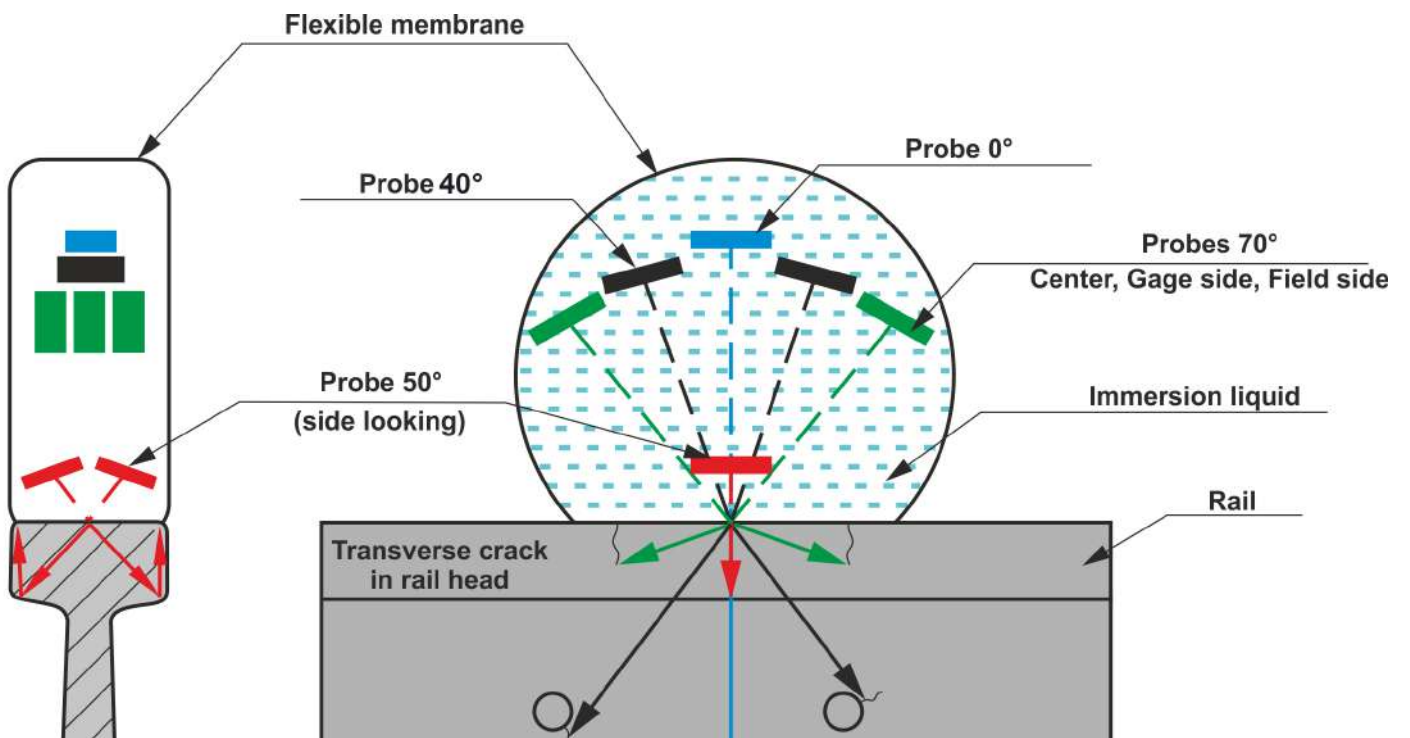

# Features of design, application and maintenance of ultrasonic single-rail flaw detectors UDS2-77 AREMA

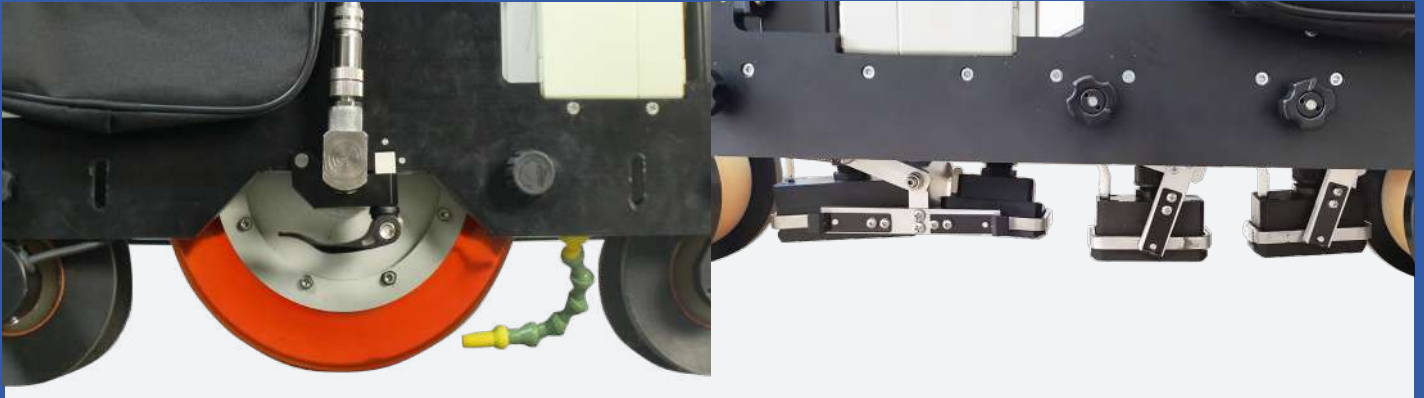

<b>UDS2-77 AREMA (RSU)</b>	<b>UDS2-77 AREMA (SL)</b>
Provides testing of rails in accordance with AREMA requirements	Provides testing of rails in accordance with AREMA requirements
Immersion probe unit design - wheel (RSU)	Sliding probe unit design (4 sliding blocks)
Number of ultrasonic probes - 11	Number of ultrasonic probes 11
0°-4 MHz	0°-4 MHz
70°-2 MHz (Head Central Forward )	70°-2 MHz (Head Central Forward )
70°-2 MHz (Head Central Backward)	70°-2 MHz (Head Central Backward)
70°-2 MHz (Head Gauge Face Forward)	70°-2 MHz (Head Gauge Face Forward)
70°-2 MHz (Head Gauge Face Backward)	70°-2 MHz (Head Gauge Face Backward)
70°-2 MHz (Head Field Face Forward)	70°-2 MHz (Head Field Face Forward)
70°-2 MHz (Head Field Face Backward)	70°-2 MHz (Head Field Face Backward)
2x40°- 2 MHz (Web, Foot Forward / Backward)	2x45°- 2 MHz (Web, Foot Forward / Backward)
2x50°- 2 MHz (Head Side Looking)	2x50°- 2 MHz (Head Side Looking)
<b>Specifics of Application</b>	
Requires a strictly vertical position of trolley during rail testing	Trolley tilt of +/- 15° is acceptable during rail testing
<b>Comparison of Costs, Repair and Maintenance</b>	
The cost of repair/replacement of the probe unit (RSU) is higher	The cost of repair/replacement of sliding probe units is smaller
The cost of soft tire replacement is smaller	The cost of sliding probe units replacement is higher
The process of soft tire replacement is more difficult	The process of sliding probes replacement is easier
<b>Comparison of flaw detectors Costs</b>	
The cost is higher	The cost is smaller
<b>Net weight (without liquid)</b>	
Weight 17 kg	Weight 23 kg

# Interface and main modes of the flaw detector software

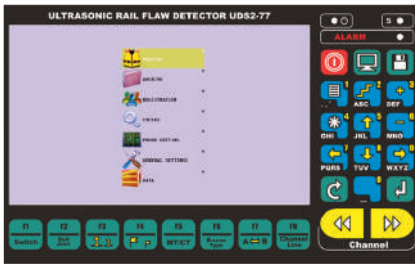

General flaw detector interface

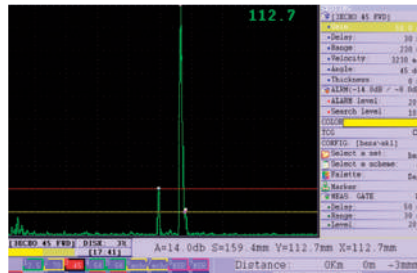

Display mode: A-Scan for one channel

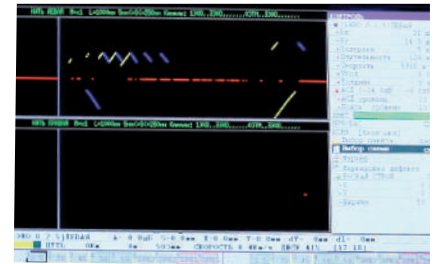

Display mode: A-Scan + B-Scan for one channel

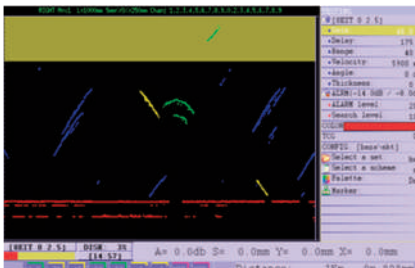

Display mode: B-Scan for one channel

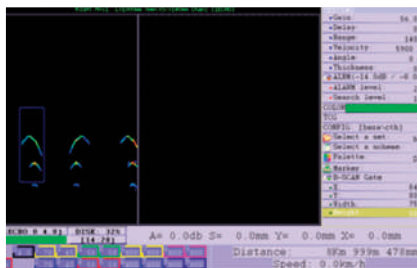

Display mode: B-Scan for one channel

## Software for test result analysis and evaluation

The "Rail Inspector" program is intended for display, analysis and evaluation of test results on PC. The program utilizes all the necessary tools to process data.

The major advantages of the program are:

- Convenient work with the database of inspected sections (stages);
- Selection of the layout of inspection channels, selection of an inspected rail, inspected rail segment, testing method;
- Measuring the notional size of defects in B-Scan mode;
- Viewing A-Scan based on the data recorded in B-Scan;
- Viewing a defectogram (B-Scan) in scroll mode or in mode of fast switch to the given coordinate;
- Path marking mode to mark suspicious segments of rail track while viewing test results;
- Sorting out test results by sensitivity level from -6 to +6 dB above or below the measuring gate level;
- Mode of viewing and producing reports on the inspected segment;
- Mode of viewing reports on confirmatory testing.

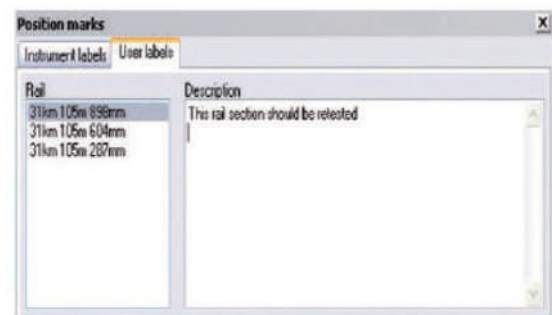
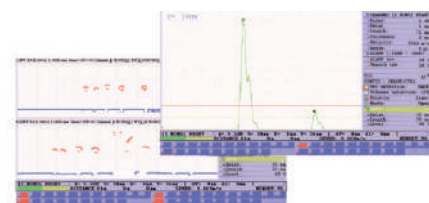
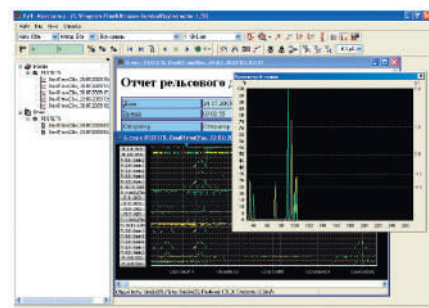



# OKO<sub>ndt</sub> GROUP



E-mail: [global-sale@oko-ndt.com](mailto:global-sale@oko-ndt.com)

[www.okondt.com](http://www.okondt.com)